

STANDARD SCR

DPAK (Plastic)

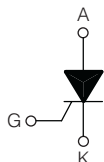
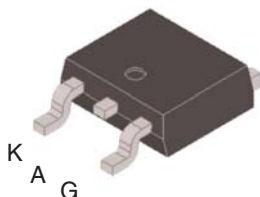

On-State Current **Gate Trigger Current**
12 Amp 2 mA to 15 mA

Off-State Voltage
200 V ÷ 800 V

These series of **Silicon Controlled Rectifier** use a high performance PNP technology.

These parts are intended for general purpose applications where high gate sensitivity is required.

Absolute Maximum Ratings, according to IEC publication No. 134

SYMBOL	PARAMETER	CONDITIONS	Value	Unit
$I_{T(RMS)}$	On-state Current	180° Conduction Angle, $T_c = 110\text{ °C}$	12	A
$I_{T(AV)}$	Average On-state Current	Half Cycle, $\Theta = 180\text{ °}$, $T_c = 110\text{ °C}$	8	A
I_{TSM}	Non-repetitive On-State Current	Half Cycle, 60 Hz	154	A
I_{TSM}	Non-repetitive On-State Current	Half Cycle, 50 Hz	140	A
I^2t	Fusing Current	$t_p = 10\text{ms}$, Half Cycle	98	A ² s
I_{GM}	Peak Gate Current	20 μs max.	4	A
P_{GM}	Peak Gate Dissipation	20 μs max.	10	W
$P_{G(AV)}$	Gate Dissipation	20ms max.	1	W
T_j	Operating Temperature		(-40 to +125)	°C
T_{stg}	Storage Temperature		(-40 to +150)	°C
T_{sld}	Soldering Temperature	10s max.	260	°C
V_{RGM}	Reverse Gate Voltage		5	V

SYMBOL	PARAMETER	CONDITIONS	VOLTAGE					Unit
			B	D	M	S	N	
V_{DRM} V_{RRM}	Repetitive Peak Off State Voltage	$R_{GK} = 1\text{ k}\Omega$	200	400	600	700	800	V

STANDARD SCR
Electrical Characteristics

SYMBOL	PARAMETER	CONDITIONS	SENSITIVITY		Uni
				09	
I_{GT}	Gate Trigger Current	$V_D = 12 V_{DC}, R_L = 140\Omega, T_j = 25^\circ C$	MIN	2	mA
			MAX	15	
V_{GT}	Gate Trigger Voltage	$V_D = 12 V_{DC}, R_L = 140\Omega, T_j = 25^\circ C$	MAX	1.3	V
V_{GD}	Gate Non Trigger Voltage	$V_D = V_{DRM}, R_L = 3.3k\Omega, R_{GK} = 220\Omega, T_j = 125^\circ C$	MIN	0.2	V
I_H	Holding Current	$I_T = 500 \text{ mA}$	MAX	20	mA
I_L	Latching Current	$I_G = 1.2 I_{GT}$	MAX	40	mA
dV / dt	Critical Rate of Voltage Rise	$V_D = 0.67 \times V_{DRM}, \text{ Gate open}, T_j = 125^\circ C$	MIN	200	V/ μ s
dI / dt	Critical Rate of Current Rise	$I_G = 2 \times I_{GT}, tr \leq 100 \text{ ns}, f = 60 \text{ Hz}, T_j = 125^\circ C$	MIN	50	A/ μ s
V_{TM}	On-state Voltage	at $I_T = 24 \text{ Amp}, tp = 380 \mu\text{s}, T_j = 25^\circ C$	MAX	1.6	V
$V_{t(o)}$	Threshold Voltage	$T_j = 125^\circ C$	MAX	0.85	V
r_d	Dynamic resistance	$T_j = 125^\circ C$	MAX	32	m Ω
I_{DRM} / I_{RRM}	Off-State Leakage Current	$V_D = V_{DRM}, R_{GK} = 1k\Omega, V_R = V_{RRM}, T_j = 125^\circ C$ $T_j = 25^\circ C$	MAX	2	mA μ A
			MAX	5	
$R_{th(j-c)}$	Thermal Resistance Junction-Case for DC	for AC 360° conduction angle		1.8	°C/W
$R_{th(j-a)}$	Thermal Resistance Junction-Amb for DC	$S = 1 \text{ cm}^2$		70	°C/W

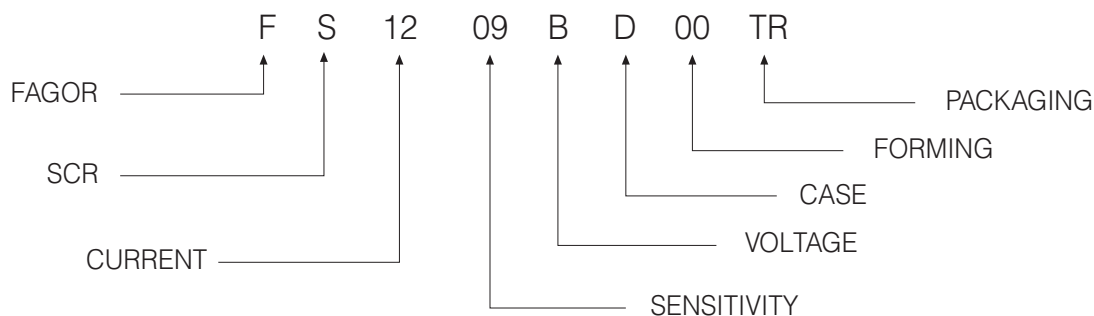
PART NUMBER INFORMATION

STANDARD SCR

Fig. 1: Maximum average power dissipation versus average on-state current.

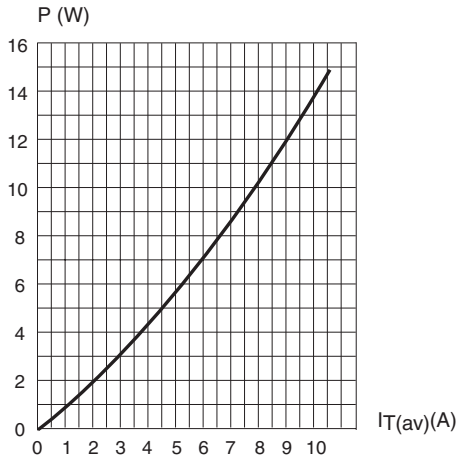

Fig. 2: Average and D.C. on-state current versus case temperature.

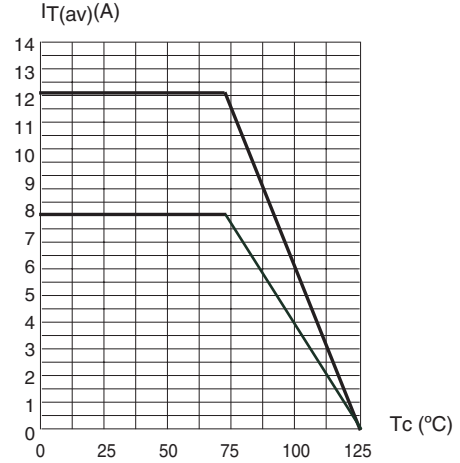

Fig. 3: Relative variation of thermal impedance junction to case versus pulse duration.

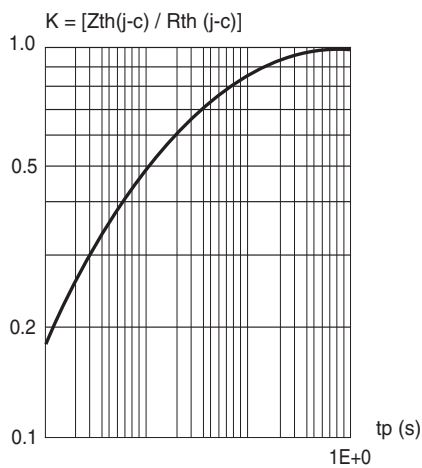

Fig. 4: Relative variation of gate trigger current, holding and latching current versus junction temperature.

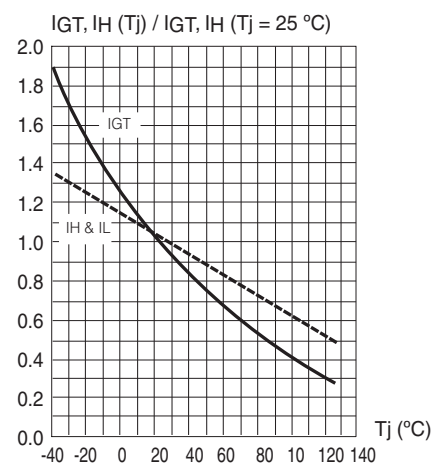

Fig. 5: Non repetitive surge peak on-state current versus number of cycles.

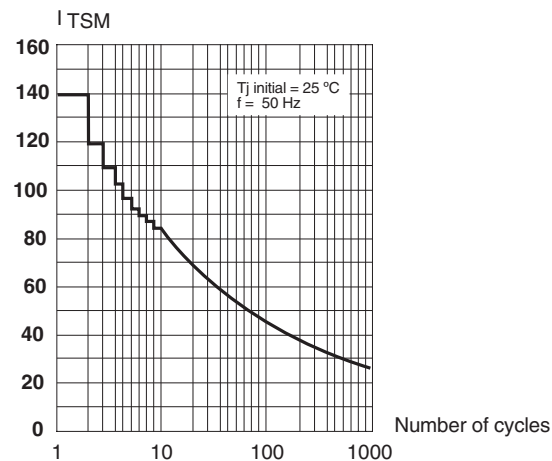
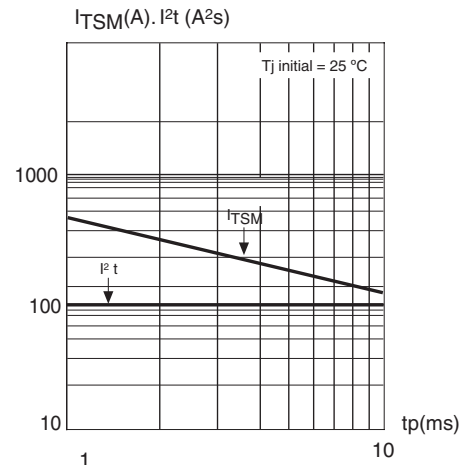

Fig. 6: Non repetitive surge peak on-state current for a sinusoidal pulse with width: $t_p < 10 \text{ ms}$, and corresponding value of I^2t .



STANDARD SCR

Fig. 7: On-state characteristics (maximum values).

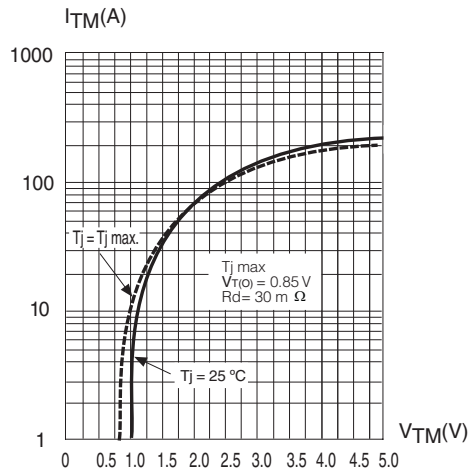

Fig. 8: DPAK RMS on-state current versus ambient temperature (printed circuit board FR4, copper thickness: 35µm), full cycle.

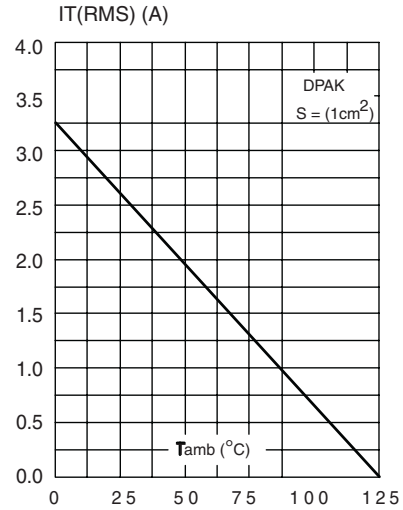
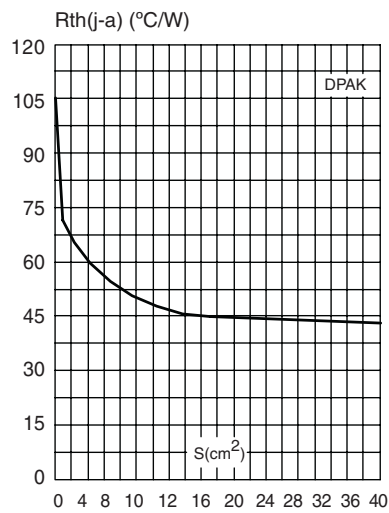

Fig. 9: DPAK Thermal resistance junction to ambient versus copper surface under tab (printed circuit board FRA, copper thickness: 35µm).



STANDARD SCR

PACKAGE MECHANICAL DATA

DPAK / TO252-AA

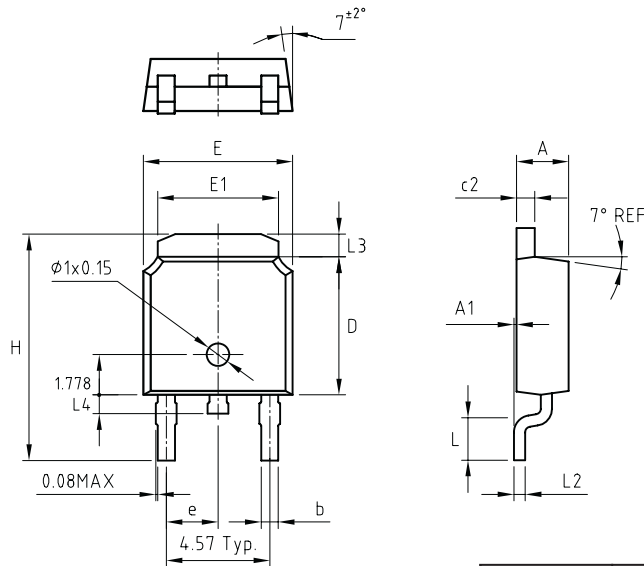

FOOT PRINT (mm)

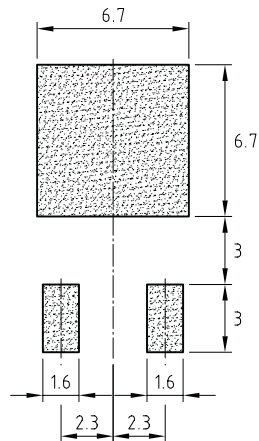

REF.	DIMENSIONS		
	Milimeters		
	Min.	Nominal	Max.
A	2.18	2.3	2.39
A1	0	0.127	0.127
b	0.64	0.75	0.89
c2	0.46	0.51	0.56
D	5.97	6.1	6.22
E	6.47	6.6	6.73
E1	5.20	5.34	5.46
e	2.28BSC		
H	9.77	10.03	10.28
L	1.31	1.44	1.57
L2	0.46	0.51	0.56
L3	0.89	1.02	1.14
L4	0.51	0.76	1.02

Marking: type number
Weight: 0.2 g